

ETEK®

IoT Smart Devices

» *Always for your safety*



**ZHEJIANG ETEK
ELECTRICAL TECHNOLOGY CO.,LTD.**

Always for your safety



RoHS

Company Introduction

Zhejiang ETEK Electric Technology Co., Ltd. (Abbreviation: ETEK Electric) is a professional manufacturing company dedicated to the research, development, production and sales of low-voltage electrical appliances. The company was established in 2011 and is located in Wenzhou City, Zhejiang Province. At present, the company has a modern factory building of more than 12,000 m². ETEK Electric focuses on the low-voltage electrical fieldwide and has advanced production management systems and production processes. Its products cover electrical safety products for household, commercial, industrial and similar facilities, such as Miniature Circuit Breakers (MCB), Residual Current Devices (RCD), Isolating Switches, Molded Case Circuit Breakers (MCCB), Distribution Board, AC Contactors, Surge Protectors (SPD), IoT Smart Circuit Breakers and Electric Vehicle Charging Facilities (EV Charger), etc.

Relying on hard work and innovation, ETEK Electric's products quickly stand out in the fiercely competitive electrical market. With its own brand 'ETEK', it has successfully entered the international market and signed overseas brand agency contracts with customers from many countries and regions. Its products are exported to the Europe, South America, Middle East, Africa, South Asia and other more than 60 countries and regions.

ETEK Electric always insists on providing customers with safe and reliable electrical products. The company has obtained ISO9001 quality system and RoHS environmental management system certification, and most of its products have also obtained CE, CB, TUV, UKCA, SEMKO, VDE, SAA and other certifications.

ETEK Electric is committed to solving the pressure and challenges of customers and creating value for customers. ETEK Electric has rich industry experience and a dynamic, professional and efficient team, we can provide customers with the best OEM, ODM services.

Growth, Efficiency, Innovation and Quality are ETEK's business goals. We are firmly committed to the field of low voltage electrical products which is your trusted partner.

We hope our products can guarantee the power safety of global users and promote the development of green energy.

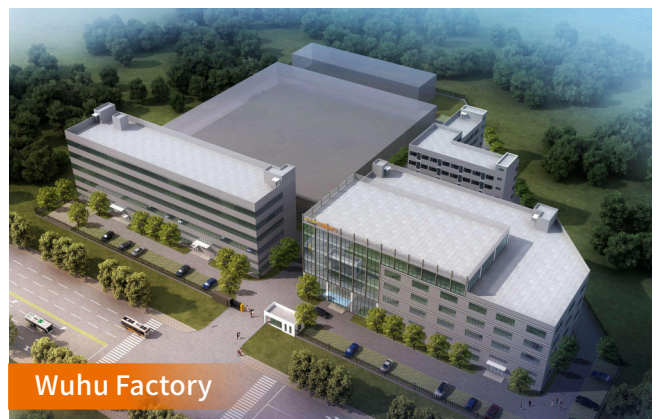

SMART CIRCUIT BREAKERS

Smart circuit breaker is an electronic device that operates the circuit breaker to open or close, monitor and collect the usage status of the circuit and the load device through the remote control. The smart circuit breaker can feedback and record the information status of circuits and equipment in real time through the Internet.

It can be remotely controlled using multiple protocols, such as RS485, WiFi, 4G/5G, etc. At the same time, collect some data in the device circuit, so that we can use the device in a more reasonable combination, so as to improve the effectiveness of power supply.

Etek Electric provides you with 3 different series of smart circuit breaker products: EKR0, EKR3 (automatic reclosing is optional), EKR3S, which can meet the different needs of different customers.



Application

It can be widely used in power grid terminal lines, unattended mobile phone base stations, elevators, air conditioners, smart phones, smart homes, smart factories, new energy vehicle charging piles, etc.



Difference between EKR0, EKR3, EKR3S

Model	EKR0 Series	EKR3 Series	EKR3S Series
Picture			
Remote control	●	●	●
Padlocker	●	●	●
Timed task	●	●	●
Automatic reclosing	/	○	/
Power metering	●	/	○
Fault feedback	●	/	●
Overvoltage protection	●	○	●
Undervoltage protection	●	○	●
Overcurrent protection	●	●	●
Overload protection	●	●	●
Leakage protection	●	○	/
Leakage detection	○	/	/
Over temperature protection	●	/	○
Short circuit protection	●	●	●
Data collection	●	/	●
Power limit	●	/	●
Fault record	●	/	●

Note: ● Standard ○ Optional / None



Overview

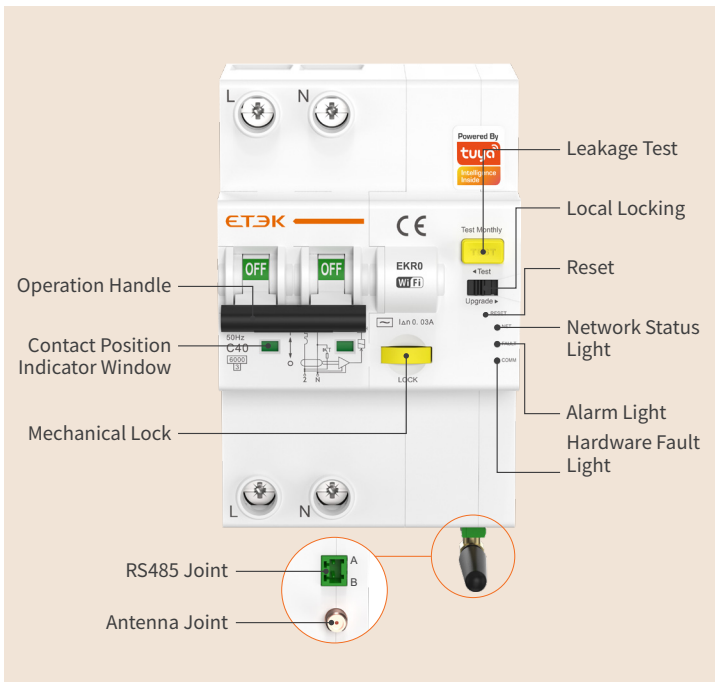

The EKR0 series smart residual current operated circuit breaker (RCBO) is suitable for indoor, AC 50Hz, rated voltage 230V/400V, rated current not exceeding 63A, industrial, commercial, civil buildings, and infrastructure low-voltage terminal distribution systems in buildings and similar places. It can also be used for infrequent on-off operations. This product integrates information collection and remote intelligent control. In addition to the overload, short circuit, and leakage protection functions of traditional leakage circuit breakers, the product also has functions such as remote control (Tuya App, RS485), electrical parameter measurement, overvoltage/undervoltage self recovery, and fault alarm.

Features

- **Automatic protection:** It automatically completes the self check of leakage protection function at a fixed time, and has a self resetting overvoltage, undervoltage protection. It is equipped with automatic inspection, and when faults are eliminated, it will automatically recover without affecting normal power supply.
- **Autonomous setting:** Automatically limit power usage based on wire diameter selection under rated value, independently set distribution parameters (such as current, power, temperature, etc.), and remotely set electricity protection warning values.
- **Fault prompt function:** Intelligent monitoring of equipment operation status, timely protection of equipment and reminder to users in case of equipment abnormalities.
- **Networking module function:** Built-in networking modules (including WiFi, 4G, etc.) are used to display device status, fault information, electricity consumption statistics, etc. on the APP through networking transmission, and can be remotely controlled.
- **Multiple working modes:** with manual/automatic selection switch and mechanical locking function.
- **Easy to install:** Adopting a modular design scheme for small circuit breakers, it can be installed on a standard 35mm guide rail, and RS485 communication uses fast plug terminal wiring.

EKRO Series Smart RCBO

Residual Current Operated Circuit Breaker

Instruction of Type code

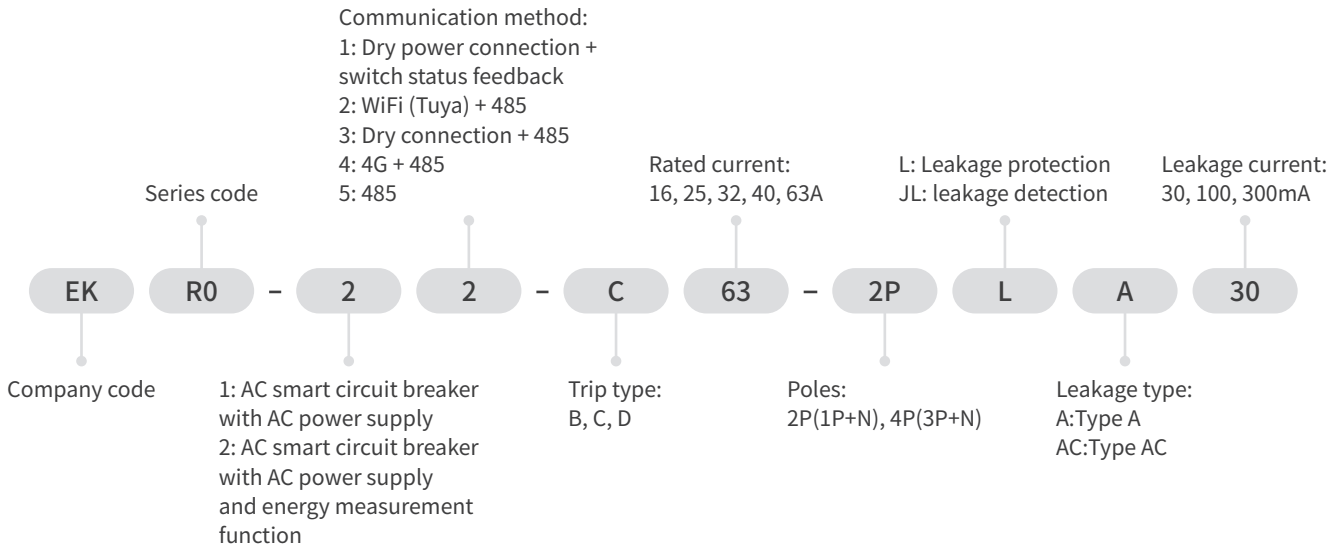

Technical Parameter

Communication method	4G, WiFi, RS485
RS485 interface baud	2400, 4800, 9600 (Default value)
Power limit	Open circuit after exceeding the limit power for 5S (default value: 22kW)
Pilot lamp	Three green LEDs
Settable parameters	Leakage detection, Overvoltage and undervoltage protection, Rated current, Voltage, power, Temperature, etc
Power consumption	< 2W
Accuracy	Voltage and current accuracy 1%, electrical energy accuracy 2%
Type of protection (electric leakage)	AC,A
Poles	1P+N, 3P+N
Rated current	16, 25, 32, 40, 63A
Rated voltage	1P+N: 230/240V, 3P+N: 400/415V
Rated frequency	50/60Hz
Rated breaking capacity	6000A
Rated sensitivity currents I Δ n	30, 100, 300mA
Residual current off-time under I Δ n	≤ 0.1s
Rated residual making and breaking capacity I Δ m	500A (I n ≤ 50A), 10I n (I n > 50A)
Rated impulse with standard voltage (1.5/50) U $_{imp}$	4kV
Thermal release characteristic	(1.13-1.45) × I n
Magnetic release characteristic	B: (3-5) × I n , C: (5-10) × I n , D: (10-20) × I n
Mechanical life	4000 Cycles
Electrical life	10000 Cycles
Operating temperature	-25°C to +40°C
Terminal connection type	Cable/Pin-type busbar
Max. terminal size for cable	Max. 25mm ²
Max. tightening torque	Max. 2.5N.m
Installation method	Mounting on 35mm DIN rail
Connection	From Top

Voltage, Current, Temperature Settings

Number	Protection type	Initial state	Initial value		Setting range		Recovery value	
1	Overvoltage	Disabled	60S	280V	5-600S	100-450V	60S	275V
2	Undervoltage	Disabled	60S	115V	5-600S	5-400V	60S	120V
3	Overcurrent	Disabled	5S	100A	5-600S	0.01-120A	/	/
4	Over power	Disabled	5S	22kW	5-600S	0.01-50kW	/	/
5	Phase loss	Disabled	60S	2V	5-600S	100V	60S	> 2V
6	Voltage imbalance	Disabled	60S	2%	5-600S	1-10%	60S	< 2%
7	Overtemperature	Disabled	30S	80°C	5-600S	90-85°C	30S	< 80°C

Application Example

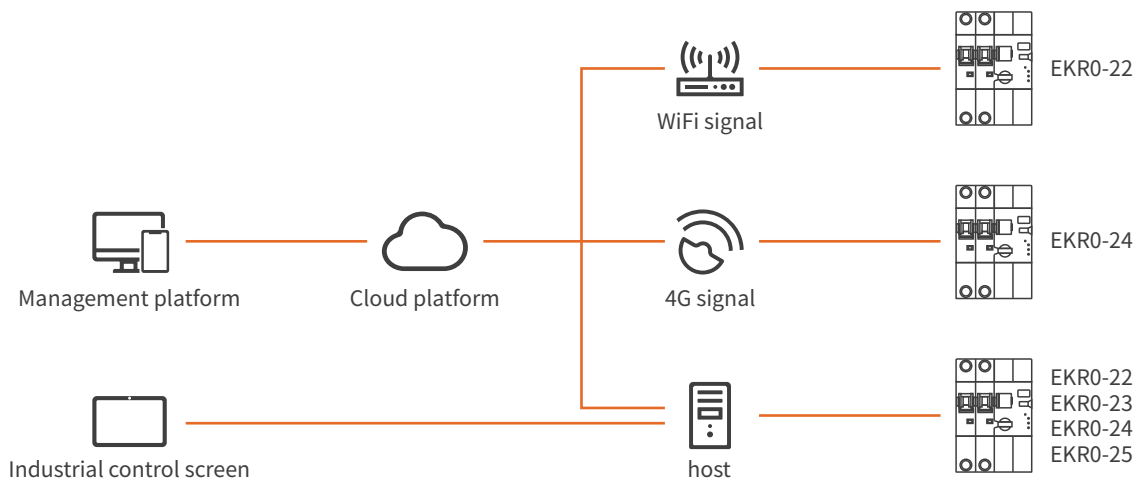

Common Problems

1. Device network distribution failure

If the device is not bound within ten minutes after installation and power on, it needs to be powered off and restarted before binding. If the device needs to reconfigure the network, briefly press the Reset button to clear the previous binding status.

2. Green light keeps flashing after installed

Check if the toggle switch is at the right end upgrade position and should be turned to the left end operation position.

3. The device cannot be remotely closed

Check whether the switch is manually opened. After manually closing it, operate it through the Tuya app or platform with RS485 connection to see if it can be opened.

Check if the mechanical padlock is pulled out.

4. 485 device unable to communicate, sending open/close command, no action

Please ensure that the equipment is in normal operation, and then check whether the A and B of RS485 cable are connected reversely, whether the communication Baud is set correctly, and whether the communication connection is abnormal.

EKRO Series Smart RCBO

Residual Current Operated Circuit Breaker

5. No feedback on operation

Check if the product wiring terminals have been tightened

Check the APP settings, notification type, and whether message notifications are allowed to be turned on

6. After power on, the indicator light does not light up

Check if the power interface is reversed and if the switch power output has power.

7. LED light status description

Operating handle	Manually move the circuit breaker up and down to control the opening and closing of the circuit breaker, with upward indicating the closing and downward indicating the opening	
Contact position indication window	Red represents closing, green represents opening	
Network status light	Flashing 300ms off, 300ms on	Connected to the network
	Flashing 300ms off, 300ms on	Remote upgrade
	Flashing 100ms off, 1900ms on	Connection to the server successful
Alarm light	100ms on, 400ms off	Mechanism locked
	100ms on, 900ms off	Manual opening
	Extinguish	No alarm
	500ms flashing	With alarm
Hardware fault light	Solid light	Press the key to reboot into boot
	Extinguish	Trouble-free
	100ms on, 400ms off	Mechanism failure
	100ms on, 100ms off	Metering fault

Product Size and Wiring Method

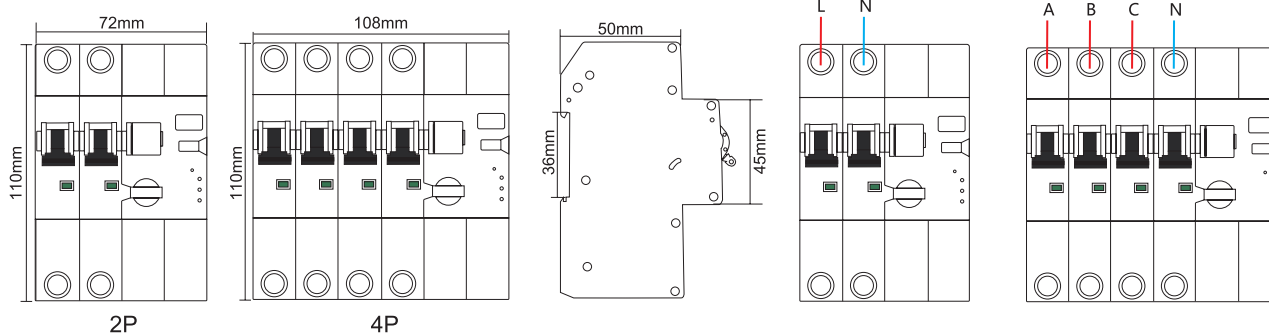



Overview

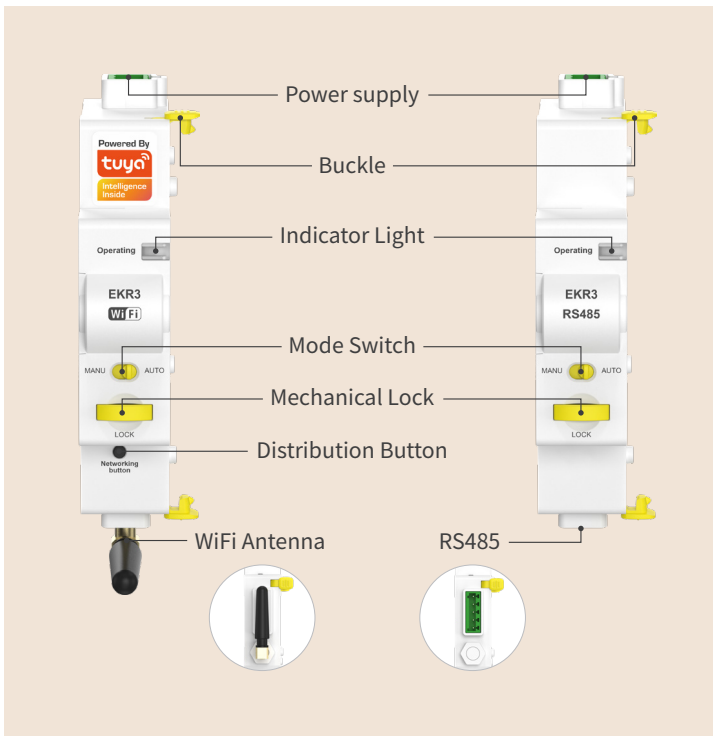

EKR3 series remote control mechanism is a compact smart control unit with a width of only 18mm. It can be adapted to MCB, RCCB (under development), and RCBO produced by ETEK Electric. Remote distribution of circuit breaker equipment can be realized through Tuya APP or a platform connected to RS485. Closing and timing switch to obtain the switching status of the equipment. At the same time, the control module can provide automatic reclosing function, when a temporary failure occurs in the power system, the product will automatically reclose after tripping to improve the reliability of the circuit power supply.



Description of Automatic, Manual Mode Switches and Mechanical Locks



Allow remote control (Tuya APP, RS485).



Remote operation is prohibited.



When the mechanical lock is pulled out, the device will enter the locked state, and the device will not be closed. Press the mechanical lock to restore it.

Functional Characteristics

- It is matched with a MCB or RCCB or RCBO to provide overload, short circuit and leakage protection. When the switch trips accidentally, it does not need to be closed manually, reducing manual maintenance costs, timely troubleshooting and improving efficiency.
- Remote opening and closing control, timing tasks, and obtaining the current switch status can be realized through Wi-Fi or a platform with RS485 connection.
- Built-in multiple times of reclosing, continuous closing failure within a certain period of time can send an alarm signal through the LED indicator or APP (for specific time and times, please refer to the parameter table, and can also be set and adjusted according to needs).
- With manual/automatic selection switch and mechanical lock function.

Automatic Reclosing Function

How Auto-Recloser Works

Auto-reclosing

In the auto state, after the fault trips and meets the closing requirements, the equipment will reclose according to the time set by the reclosing switch. If the device fails to close within the specified time, the device will no longer reclose, and at the same time output an alarm signal (via Tuya App or RS485). In this state, opening and closing can be achieved through remote control or manual control.

Auto reclosing successful

If the switch is successfully closed, it will no longer trip within the specified time (15 minutes for EKR3-WiFi, 60 seconds for EKR3-RS485), which is defined as successful switch-on. After successful switch-on, the number of frequency the device has been reclosed is automatically cleared, and the counter restarts count. (Any opening and closing behavior controlled by humans will clear the number of reclosing times)

Automatic, Manual, Padlock mode

AUTO mode, manually open the circuit breaker, the default is fault trip, and the device will start to automatically reclose according to the program setting. MANU mode, the automatic reclosing and remote control functions will be invalid, and the brake can be opened or closed manually. Pull out the mechanical padlock on the module, and the device will enter the locking padlock mode to achieve local locking, ensuring that operators can perform maintenance work in a safe state.

Reclosing Function Diagram for EKR3-WiFi

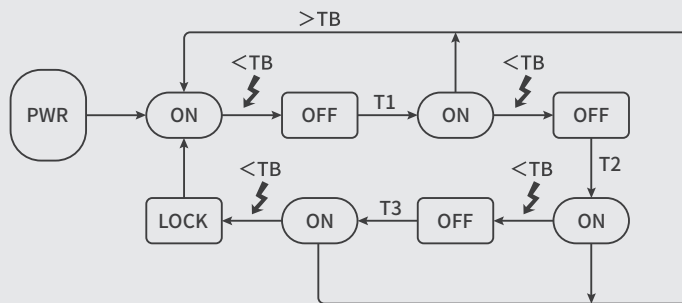

TB: 900S, T1: 10S, T2: 60S, T3: 300S. (All times are default values, support customization)
 Trip cause: Fault check includes over-voltage, phase loss, neutral disconnection, short circuit, earth leakage, manual opening.

When the circuit breaker is opened by an unknown fault (manual opening, short circuit trip, leakage trip, overload trip), it will automatically reclose, a total of 3 reclosing sequences, and each reclosing sequence time interval (T1, T2, T3). After successful reclosing, if a trip occurs again within the stable time TB, it will enter the next reclosing sequence, otherwise, if no trip occurs within TB, the reclosing sequence will be cleared. If the circuit breaker fails to reclose after 3 times of reclosing, manual closing or remote control closing is required to clear the fault.

Indicator Light Description	
Green light is always on	Connect to cloud server
Green light flashes for 100ms	Mechanism failure
Green light flashes on for 100ms and off for 900ms	Manual, Padlock mode
Green light flashes for 500ms	Configuration network
Green light flashes for 5000ms	Connect to router
Green light flashing 100ms off 900ms on	Within the time TB
Green light flashing 1700ms off 100ms on 100ms off 100ms on	Automatic reclose waiting time T (T2, T3)

Reclosing Function Diagram for EKR3-RS485

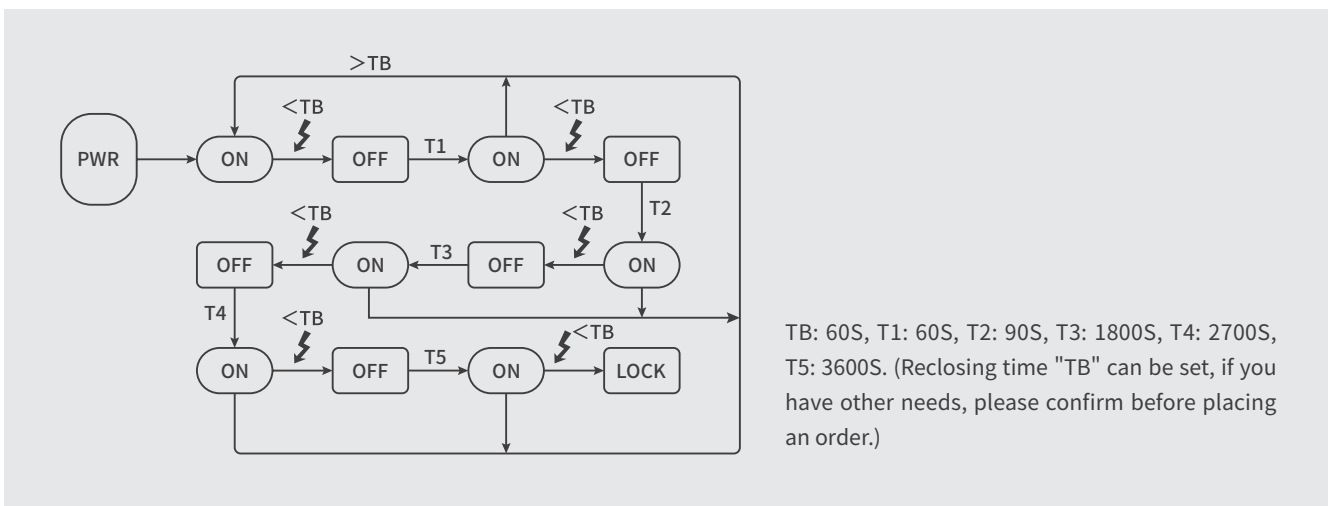

When the circuit breaker is opened by an unknown fault (manual opening, short-circuit tripping, leakage tripping, overload tripping), it will automatically reclose, a total of 5 reclosing sequences, and each reclosing sequence time interval (T1, T2, T3, T4, T5). After successful reclosing, if a trip occurs again within the stable time TB, it will enter the next reclosing sequence, otherwise, if no trip occurs within TB, the reclosing sequence will be cleared. If the circuit breaker fails to reclose after 5 times of reclosing, manual closing or remote control closing is required to clear the fault.

Indicator Light Description	
Red light is always on	Auto Mode Trip
Red light flashes for 100ms	Auto Mode - Motor Reset Failed or Cycle Close Failed
Red light flashes for 500ms	Auto mode overvoltage and undervoltage trip
Green light is always on	Auto mode closing, remote opening, signal opening
Green light flashes for 100ms	Automatic reclose waiting time
Yellow light is always on	Manual mode opening, closing

Instruction of Type code

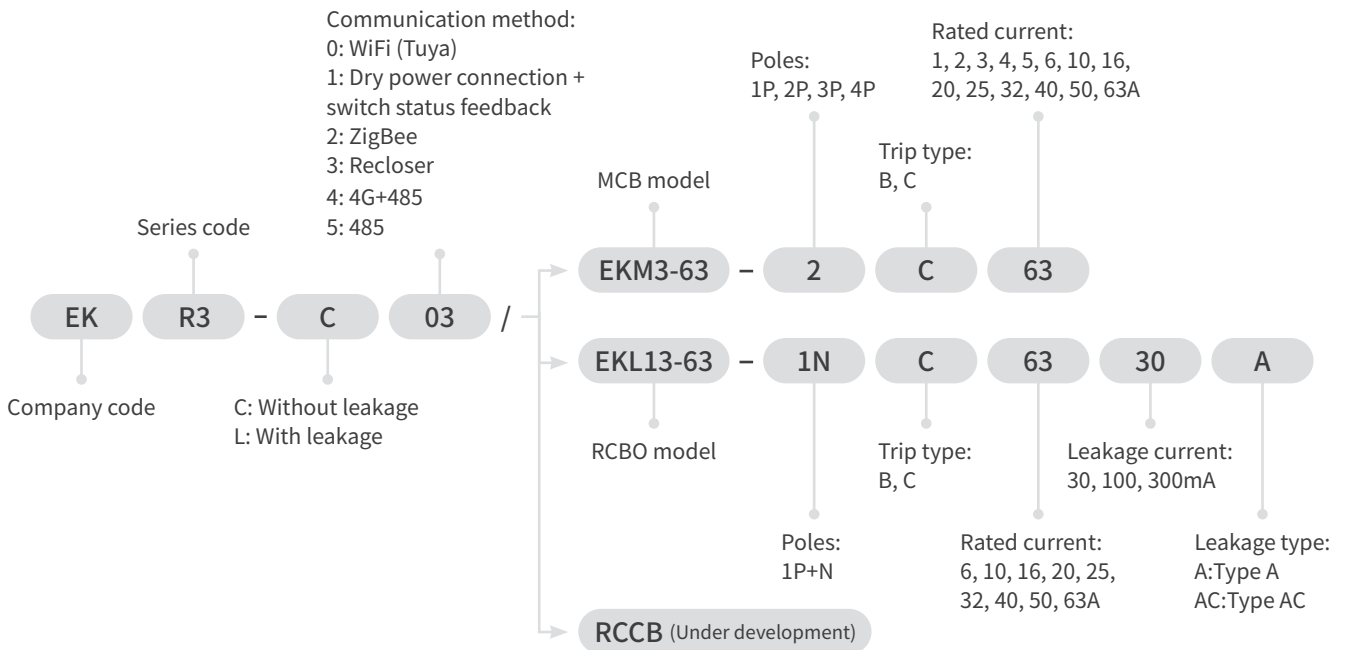

Technical Parameter

Model	EKR3-WiFi	EKR3-RS485
Communication method	WiFi, ZigBee	RS485
Supply terminals	L-N	
Rated voltage Ue	AC 230V	
Power consumption	AC max.1VA (standby), max.20VA (action)	
Supply voltage tolerance	±10%	
Status Indicator	Green LED	Red, green and yellow tri-color LED
Trip time	≤ 1s	
Reclosing times	3 times (customizable)	5 times
Reclosing time	First time: 10 seconds; Second time: 60 seconds; Third time: 300 seconds; Customizable, cannot be changed after initial setup	First time: 60 seconds; Second time: 90 seconds; The third time: 1800 seconds; Fourth time: 2700 seconds; Fifth time: 3600 seconds; Adjustable time setting range: 60-3600 seconds.
Reset reclosing times	No more tripping or manual reset within 15 minutes after successful closing	No tripping or manual reset within 60 seconds after successful closing, Adjustable time setting range: 5-600 seconds.
Mechanical life	10000 Cycles	
Electrical life	4000 Cycles	
Ambient temperature	-20°C to +55°C (-4 °F to 131 °F)	
Storage temperature	-35°C to +75°C (-22 °F to 158 °F)	
Installation	Mounting on 35mm DIN rail	
Pollution degree	IP20	
Supply terminal size for cable	Max. 2.5mm ²	
Dimensions	91×18×61mm	
Compatible Device	MCB (EKM3-63), RCBO (EKL3-63, EKL13-63), from ETEK (More compatible devices are in development)	

Fault Description

1. The Device Cannot be Closed Remotely?

Check whether the remote lock is turned on in the APP.

Check whether manual opening has been carried out First, manually close and then operate on the APP to check if it can be closed and opened.

Whether the mechanical padlock is pulled out or not.

2. 485 Device cannot communicate, send opening/closing command, no action?

Please ensure that the device is in normal operation, and then check whether A and B of the RS485 line are reversed, whether the communication baud rate is set correctly, and whether there is any abnormality in the communication connection.

3. Operation Without Feedback?

Check whether the product terminals have been tightened.

Check the APP settings, notification type and whether the message notification is enabled.

4. After Power On, The Indicator Light Does Not Light Up?

Check whether the power interface is reversed, whether the switching power supply output has power or not.

5. LED light status description (Without reclosing)

WiFi, ZIGBEE	
Green light is always on	Connect to cloud server
Green light flashes for 100ms	Mechanism failure
Green light flashes for 100ms	Padlock mode
Green light flashes for 500ms	Configuration network
Green light flashes for 5000ms	Connect to router
RS485, Dry contact	
Red light is always on	Auto Mode Trip
Red light flashes for 100ms	Auto Mode - Motor Reset Failed or Cycle Close Failed
Red light flashes for 500ms	Auto mode overvoltage and undervoltage trip
Green light is always on	Auto mode closing, remote opening, signal opening
Green light flashes for 100ms	Automatic reclose waiting time
Yellow light is always on	Manual mode opening, closing

EKR3 Series

smart control unit for MCB, RCCB, RCBO

MCB EKM3-63 Technical Parameters

Standard	IEC/EN60898-1	IEC/EN60947-2
Protection	Overcurrent and short circuit	
Type of trip	Thermo-magnetic	
No.of poles	1P,2P,3P,4P	
Rated currents (In)	1,2,3,4,5,6,10,16,20,25,32,40,50,63A	
Rated voltage (Ue)	240/415V~	
Rated frequency	50/60Hz	
Rated breaking capacity	6,000A	
Energy Limiting Class	3	
Rated impulse withstand voltage(1.5/50) Uimp	6,000V	
Dielectric test voltage at Ind. Freq.for 1 min	2kV	
Thermal release characteristic	(1.13-1.45) x In	(1.05-1.30) x In
Magnetic release characteristic	B: (3-5) x In, C: (5-10) x In	(8-12) x In
Electrical life	8,000 Cycles	
Mechanical life	20,000 Cycles	
Contact position indicator	Yes	
Protection degree	IP20	
Ambient temperature	-5°C to +40°C Max.95%humidity	
Terminal connection type	Cable/Pin-type busbar	
Max.terminal size for cable	25mm ²	
Max.tightening torque	2.5N.m	
Installation	Mounting on 35mm DIN rail	
Connection	From top and bottom	

EKR3 with MCB EKM3-63 Product Size and Wiring Method

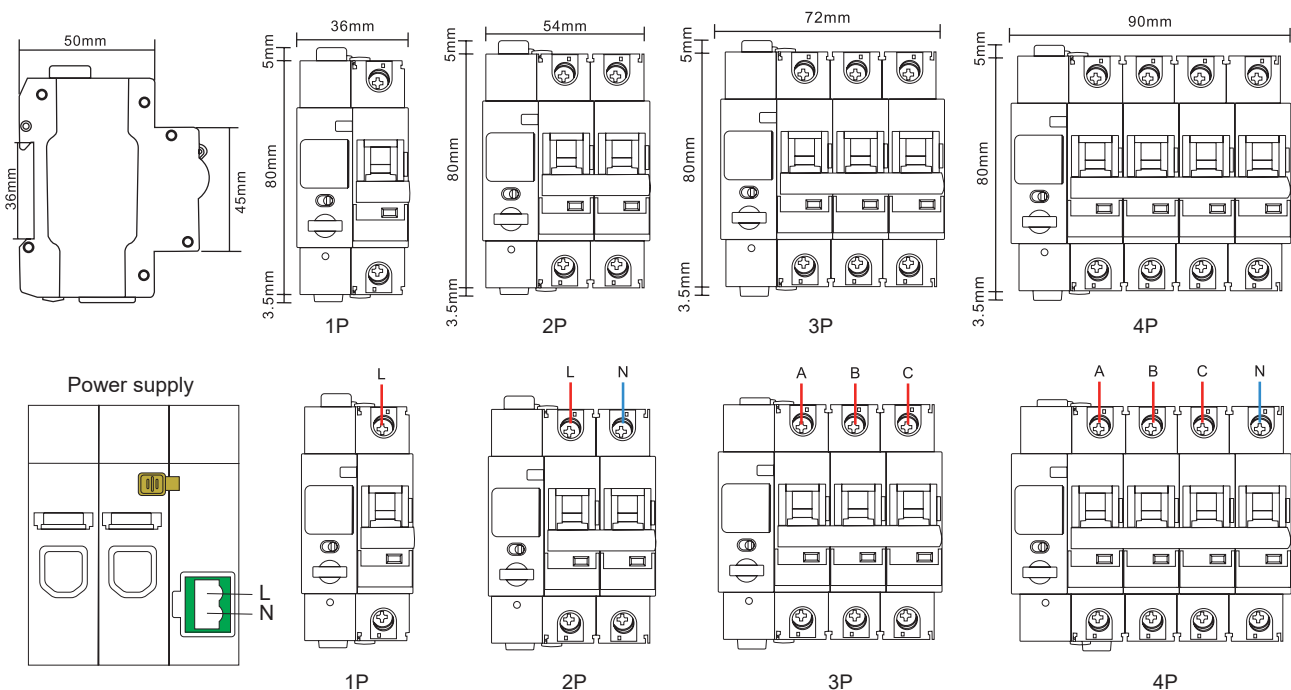

RCBO EKL13-63 Technical Parameters

Standard	IEC/EN61009-1
Protection	Ground fault, Overcurrent and short circuit, Over-voltage(selectable)
Type of trip	Ground fault: Electronic
	Overload and short circuit: Thermo-magnetic
Type of protection (electric leakage)	AC,A
No.of poles	1P+N 2module, N line with disconnected
Rated currents (In)	6,10,16,20,25,32,40,50,63A
Rated sensitivity currents I Δ n	10,30,100,300mA
Residual current off-time under I Δ n	≤ 0.1s
Rated residual making and breaking capacity(I Δ m)	500A (In ≤ 50A), 10In (In>50A)
Rated voltage (Ue)	230/240V~
Rated frequency	50/60Hz
Rated breaking capacity	6,000A
Energy Limiting Class	3
Rated impulse withstand voltage(1.5/50) Uimp	4,000V
Dielectric test voltage at Ind. Freq.for 1 min	2kV
Thermal release characteristic	(1.13-1.45) x In
Magnetic release characteristic	B: (3-5) x In, C: (5-10) x In
Electrical life	4,000 Cycles
Mechanical life	10,000 Cycles
Contact position indicator	Yes
Ground fault indicator	Yes
Protection degree	IP20
Ambient temperature	-25°C to +40°C , Max.95% humidity
Terminal connection type	Cable/Pin-type busbar/Fork-type busbar
Max.terminal size for cable	25mm ²
Max.tightening torque	2.5N.m
Installation	Mounting on 35mm DIN rail
Connection	From top and bottom

EKR3 with MCB EKL13-63 Product Size and Wiring Method

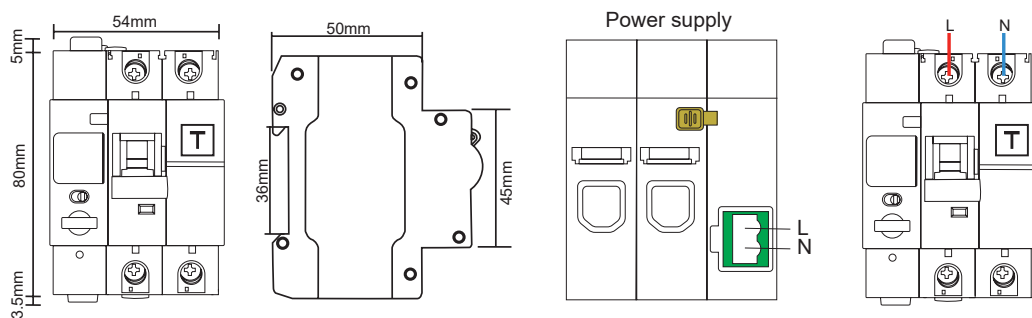

EKR3S Series

Smart Circuit Breaker

ETEK®



Overview

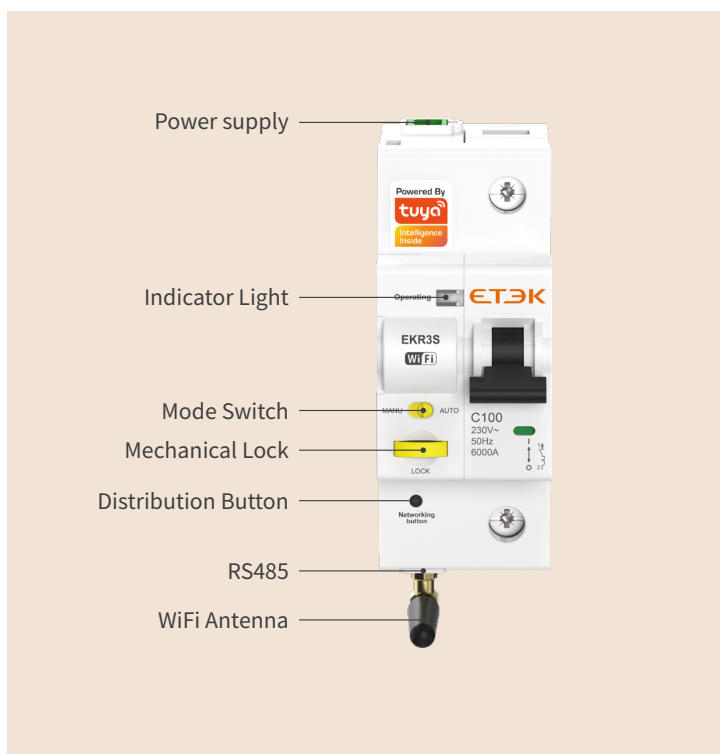

EKR3S smart circuit breaker, using electronic technology to control the normal operation of traditional circuit breakers, can monitor equipment status information in real time, including voltage, current, temperature, power, power consumption and various fault states (overvoltage, undervoltage, overload, overtemperature, etc.) Information, etc. can be reported to the client, and the protection threshold can also be set by itself. This product is an independent integrated equipment device, you can view some information of the device and set related parameters, and the operation is more humanized. After the product is connected to the Internet, it can display product information, remote control, timing, etc. on the Tuya APP.



Features

- It can realize remote control and closing through Tuya APP, and can also be controlled regularly.
- The single-phase smart circuit breaker can monitor power parameters and power parameters in real time.
- Mechanical padlock, after being pulled out during maintenance, cannot be closed locally and remotely to ensure the safety of maintenance operations.
- With overcurrent and overload protection functions, the protection threshold can be set.
- It has the function of over-under-voltage and over-temperature protection, at the same time, you can set the alarm reminder through the Tuya APP.

Instruction of Type code

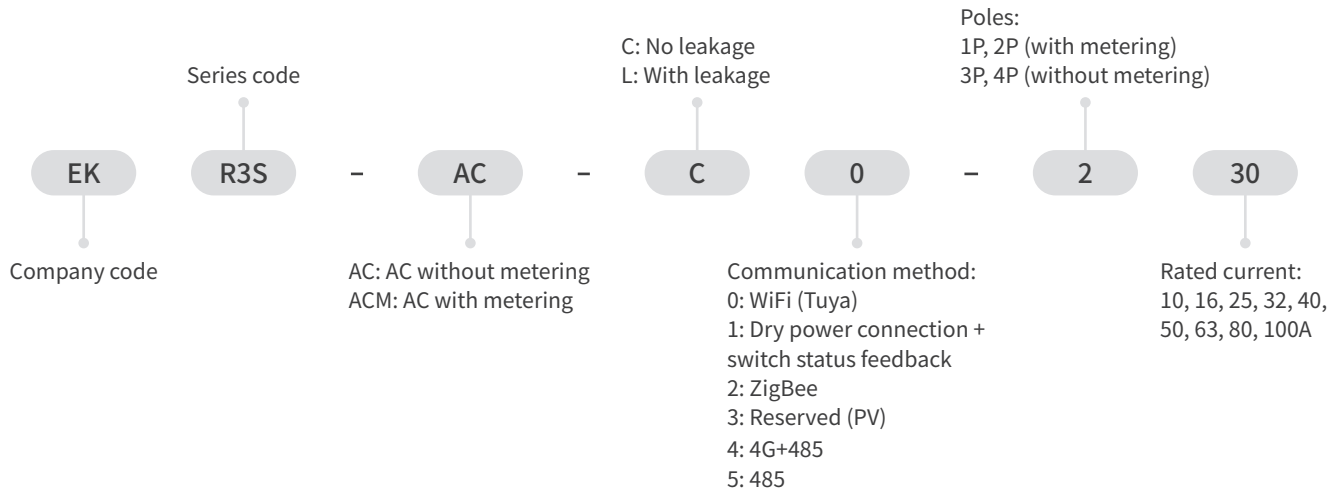

Technical Parameter

Poles	1P, 2P	3P, 4P
Rated current	10, 16, 25, 32, 40, 50, 63, 80, 100A	
Rated operating voltage and frequency	220/230VAC 50Hz	380/400VAC 50Hz
Breaking ability	6kA	
Trip type	C type, D type	
Standby power	<3W	
Trip time	≤ 0.1S	
Short circuit time	≤ 0.04S	
Control mode	Manual and automatic	
Communication method	WiFi, ZIGBEE, 485	
Installation site requirements	The altitude does not exceed 3000m	
Temperature requirements	-25°C to +70°C	

Voltage, Current, Temperature Settings

Number	Protection type	Initial state	Initial value		Setting range		Recovery value	
1	Overvoltage	Disabled	60S	280V	5-600S	100-450V	60S	275V
2	Undervoltage	Disabled	60S	115V	5-600S	5-400V	60S	120V
3	Overcurrent	Disabled	5S	100A	5-600S	0.01-120A	/	/
4	Over power	Disabled	5S	22kW	5-600S	0.01-50kW	/	/
5	Phase loss	Disabled	60S	2V	5-600S	100V	60S	> 2V
6	Voltage imbalance	Disabled	60S	2%	5-600S	1-10%	60S	< 2%
7	Overtemperature	Disabled	30S	80°C	5-600S	90-85°C	30S	< 80°C

EKR3S Series

Smart Circuit Breaker



LED Light Status Description

Red light is always on	Automatic mode, tripping, manual opening
Red light flashes for 100ms	Mechanical lock, command lock
Red light flashes for 500ms	Over-voltage, over-temperature, over-current, overload
Red light flashes for 1000ms	The automatic cycle closing fails, and the automatic closing fails
Green light is always on	automatic mode: manual closing, command closing, automatic closing, signal closing, timing closing, Remote opening, signal opening, timing opening
Green light flashes for 100ms	Network configuration status (priority display)
Green light flashes for 500ms	WiFi connected to the router (4G is networking)
Green light flashes for 1000ms	Automatic coincidence, stable
Red and green light flashing alternately for 100ms	Mechanism failure
Red and green light flashing alternately for 1000ms	Boot upgrade mode or OTA upgrade
Yellow light is always on	Manual mode
Light flashes for 100ms off 1900ms on	The light of the continuous display of successful networking is switched to this mode, regardless of the red light, green light, orange light, fault status priority display fault indication

Product Size and Wiring Method

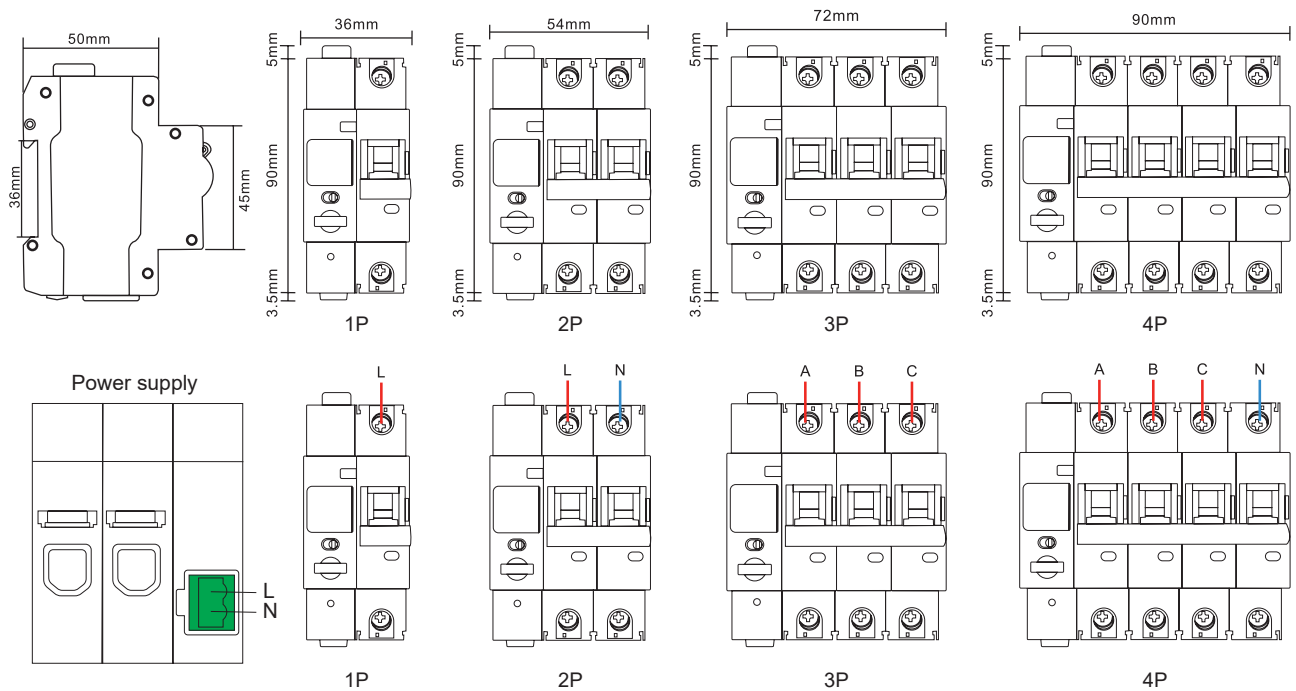

Applicable Scope

EKWF WiFi smart switch controller cooperate with the corresponding APP to realize the following functions:

- Support smart configuration for fast networking.
- Support multiple control types: switch, timer switch, cycle control, etc.
- Support WLAN local control and remote control.
- Access to mainstream voice-activated assistants such as Tmall Genie, DuerOS, Xiao Ai, Alexa, Google, etc, Voice-activated smart device sharing and cloud account device sharing function.
- APP support Android and iOS systems.
- Application: Home control system, Building automation, Industrial control system, Medical and electrical equipment.

Modular Contactor

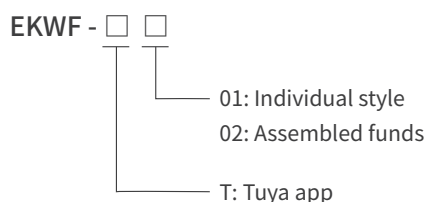

(Example: EKWF-T02, Tuya, assembled)

Technical Data

WiFi Standard	2.4GHz B/G/N
Working Mode	STA/AP/STA+AP
Certification Standards	IEC/EN 60947-1, IEC/EN 60947-4-1, IEC/EN 60947-5-1
Certificate	CE
Enclosure protection degree	IP20
Ambient temperature	Operation temperature limits: -35°C ~+70°C . Normal operation temperature range: -5°C ~+40°C . The 24-hour average temperature should not exceed +35°C . For use beyond the normal operation temperature range.
Altitude	Not exceeding 2000 m above sea level
Atmospheric conditions	The relative humidity should not exceed 50% at the upper temperature limit of +70°C . A higher relative humidity is allowed at a lower temperature, e.g. 90% at +20°C . Special precautions should be taken against occasional condensation due to humidity variations.
Installation conditions	The angle between the installation surface and the vertical surface should not exceed ±5° .

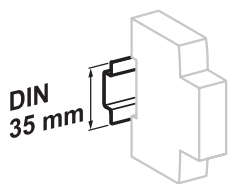

Clip on DIN rail 35 mm

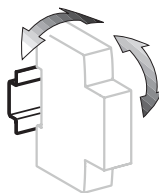

±30° vertical

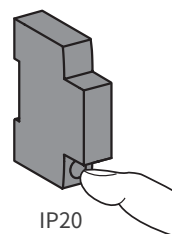

IP20

EKWF Series

WiFi Smart Switch Controller for Modular Contactor



Installation



1. First, we need to use the hook at the lower right side of the WiFi controller.

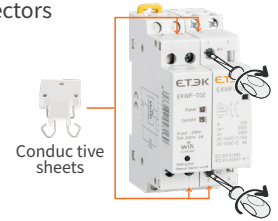

2. Then we install conductive connectors at NO(A1) and N (A2).



User Guide





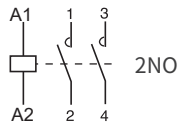
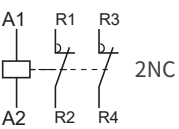

- 1   → 2 Allow all permissions during installation. → 3 Register an account and login.
- Search for "Tuya" or scan this QR code to download and install Tuya APP. ↓
- 6 Select "Quick Mode (Touch)", the next step. ← 5 Click the Add button on the Tuya Smart APP. ← 4 Add device: Press and hold the black button for about 7 seconds until the WiFi indicator flashes quickly. (flashes twice for one second)
- ↓
- 7 Enter the WiFi password that the phone is currently connected to. → 8 Name the device and complete adding. → 9 When the WiFi indicator light of the device is always on, remote control can be performed.

Scope of Application

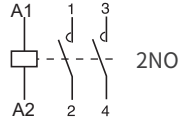
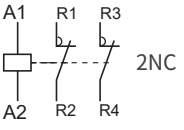
EKWF series WiFi smart switch controller, the shell is made of PC flame retardant material, which is safer to use; The maximum load of 230V/2a can be extended to 125A through the contactor, using standard WiFi: 2.4GHz b/g/n.

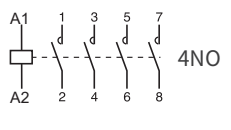
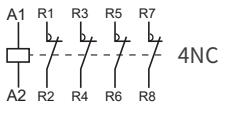
Automatic Type Product Selection Form

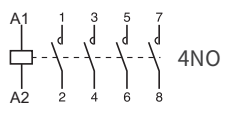
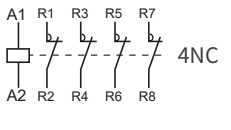
Modules	Contactor Model	Rated Current		Coil voltage VAC	Circuit Diagram
		AC-1, AC-7a	AC-3, AC-7b		
 <p>1P, 1 Modules</p>	EKWF+EKMF1620	16A	6A	24 110 230	
	EKWF+EKMF2020	20A	7A		
	EKWF+EKMF2520	25A	9A		
	EKWF+EKMF1602	16A	6A		
	EKWF+EKMF2002	20A	7A		
	EKWF+EKMF2502	25A	9A		

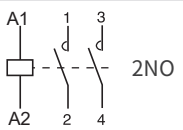
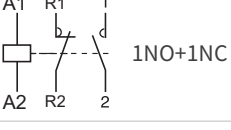
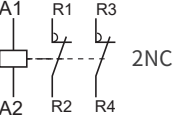
Modules	Contactor Model	Rated Current		Coil voltage VAC	Circuit Diagram
		AC-1, AC-7a	AC-3, AC-7b		
 <p>1P, 1 Modules</p>	EKWF+EKMF3220	32A	12A	24 110 230	
	EKWF+EKMF4020	40A	18A		
	EKWF+EKMF6320	63A	25A		
	EKWF+EKMF3202	32A	12A		
	EKWF+EKMF4002	40A	18A		
	EKWF+EKMF6302	63A	25A		
 <p>1P, 1 Modules</p>	EKWF+EKMF1640	16A	6A	24 110 230 380	
	EKWF+EKMF2040	20A	7A		
	EKWF+EKMF2540	25A	9A		
	EKWF+EKMF1604	16A	6A		
	EKWF+EKMF2004	20A	7A		
	EKWF+EKMF2504	25A	9A		
 <p>1P, 1 Modules</p>	EKWF+EKMF3240	32A	12A	24 110 230 380	
	EKWF+EKMF4040	40A	18A		
	EKWF+EKMF6340	63A	25A		
	EKWF+EKMF3204	32A	12A		
	EKWF+EKMF4004	40A	18A		
	EKWF+EKMF6304	63A	25A		
 <p>1P, 1 Modules</p>	EKWF+EKMF8020	80A	32A	24 110 230	
	EKWF+EKMF10020	100A	40A		
	EKWF+EKMF12520	125A	50A		
	EKWF+EKMF8011	80A	32A		
	EKWF+EKMF10011	100A	40A		
	EKWF+EKMF12511	125A	50A		
	EKWF+EKMF8002	80A	32A		
	EKWF+EKMF10002	100A	40A		
EKWF+EKMF12502	125A	50A			

EKWF Series

WiFi Smart Switch Controller for Modular Contactor

Overall and Installation Dimension (mm)

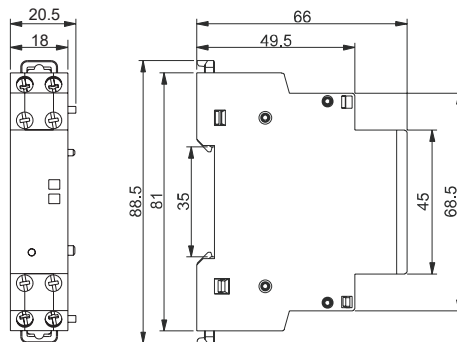

Connection Diagram

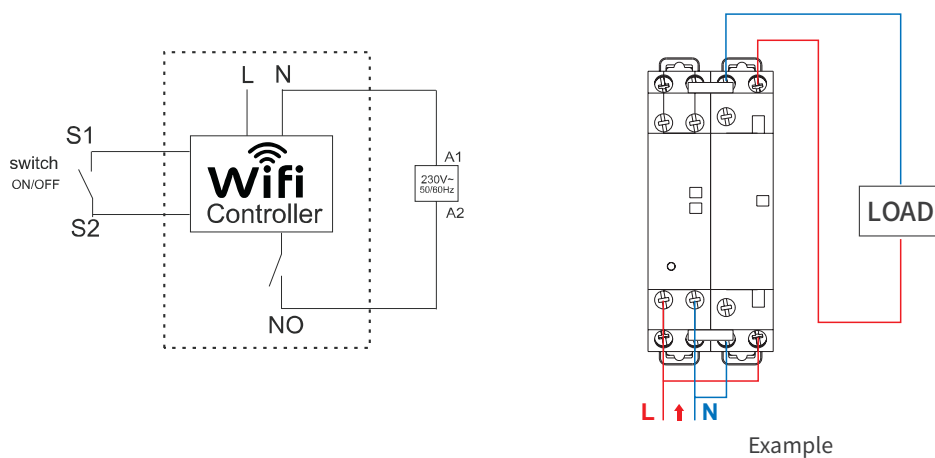

Tel-
0086-577-62780116

Fax-
0086-577-62774090

Email-
sales@etek-electric.com

No. 288 Wei 17th Road,
Economic Development Zone,
Yueqing City Zhejiang China.

ETEK[®]
ETEK ELECTRIC

ZHEJIANG ETEK
ELECTRICAL TECHNOLOGY CO.,LTD.